

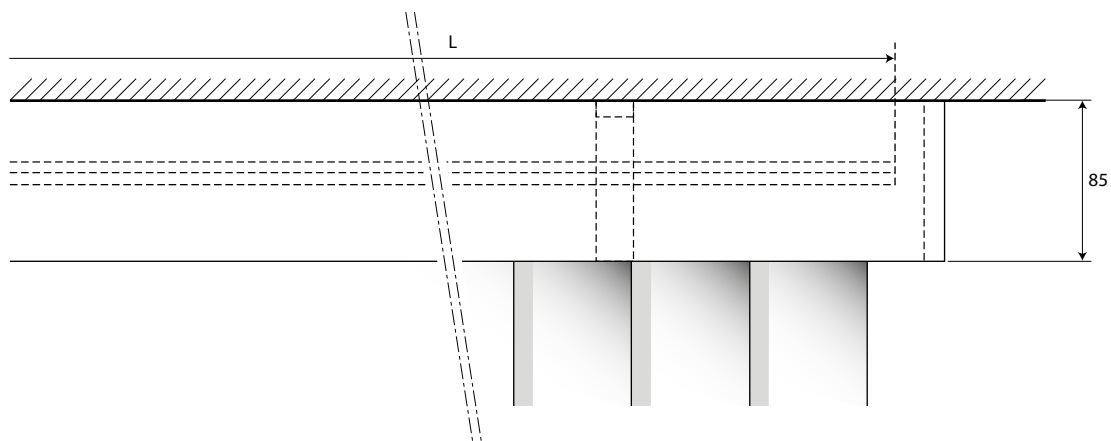



PEGASO



Cod. 923A03

Sistema a parete - 3 vie
Wall system - 3 ways
Système de face - 3 voies
Wandmontage - 3läufig
Sistema pared - 3 vías
System ścienny - 3 biegi

Cod. 923A04

Sistema a parete - 4 vie
Wall system - 4 ways
Système de face - 4 voies
Wandmontage - 4läufig
Sistema pared - 4 vías
System ścienny - 4 biegi

Cod. 923A05

Sistema a parete - 5 vie
Wall system - 5 ways
Système de face - 5 voies
Wandmontage - 5läufig
Sistema pared - 5 vías
System ścienny - 5 biegi

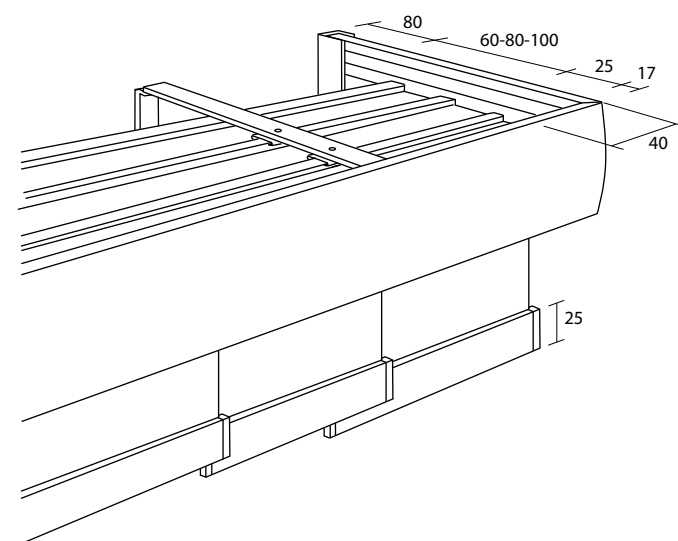

25



67



312

PEGASO

FIN 25 - 312

3 vie - 3 ways - 3 voies - 3läufig - 3 vías - 3 biegi

L - cm CT	140						160						180						200					
	A	B	C	D	E	F	A	B	C	D	E	F	A	B	C	D	E	F	A	B	C	D	E	F
160																								
180																								
200																								
220																								
240																								
260																								
280																								
300																								
320																								
LP - cm	53						59						66						73					

L - cm CT	220						250						300					
	A	B	C	D	E	F	A	B	C	D	E	F	A	B	C	D	E	F
160																		
180																		
200																		
220																		
240																		
260																		
280																		
300																		
320																		
LP - cm	79						90						106					

Maggiorazioni - Surcharges - Suppléments - Zuschläge - Suplementos - Dodatkowa opłata

L - cm	140	160	180	200	220	250	300
67							

Movimento a corda - Corded systems - Tirage - Schnurbedienung - Movimiento de cuerda - Koszt mechanizmu

L - cm	140	160	180	200	220	250	300
25 - 67 - 312							

FIN = Finitura - Finish - Finition - Fertigung - Acabado - Wykończenie

L = Larghezza sistema (cm) - System width (cm) - Largeur système (cm) - Gesamtbreite (cm) - Ancho sistema (cm) - Szerokość systemu (cm)

CT = Classe tessuto - Fabric category - Catégorie tissu - Gewebegruppe - Categoría tejido - Klasa tkaniny

C = Altezza tessuto (cm) - Fabric height (cm) - Hauteur de la toile (cm) - Stoff Höhe (cm) - Altura tejido (cm) - Wysokość tkaniny (cm)

LP = Larghezza pannello (cm) - Panel width (cm) - Largeur panneau (cm) - Paneelebreite (cm) - Ancho panel (cm) - Szerokość panelu (cm)

FIN 25 - 312

4 vie - 4 ways - 4 voies - 4läufig - 4 vías - 4 biegi

L - cm CT	180						200						220						240					
	A	B	C	D	E	F	A	B	C	D	E	F	A	B	C	D	E	F	A	B	C	D	E	F
160																								
180																								
200																								
220																								
240																								
260																								
280																								
300																								
320																								
LP - cm	51						56						61						66					

L - cm CT	260						280						300						320					
	A	B	C	D	E	F	A	B	C	D	E	F	A	B	C	D	E	F	A	B	C	D	E	F
160																								
180																								
200																								
220																								
240																								
260																								
280																								
300																								
320																								
LP - cm	71						76						81						86					

Maggiorazioni - Surcharges - Suppléments - Zuschläge - Suplementos - Dodatkowa opłata

L - cm	180	200	220	240	260	280	300	320
67								

Movimento a corda - Corded systems - Tirage - Schnurbedienung - Movimiento de cuerda - Koszt mechanizmu

L - cm	180	200	220	240	260	280	300	320
25 - 67 - 312								

FIN = Finitura - Finish - Finition - Fertigung - Acabado - Wykończenie
L = Larghezza sistema (cm) - System width (cm) - Largeur système (cm) - Gesamtbreite (cm) - Ancho sistema (cm) - Szerokość systemu (cm)
CT = Classe tessuto - Fabric category - Catégorie tissu - Gewebegruppe - Categoría tejido - Klasa tkaniny
C = Altezza tessuto (cm) - Fabric height (cm) - Hauteur de la toile (cm) - Stoff Höhe (cm) - Altura tejido (cm) - Wysokość tkaniny (cm)
LP = Larghezza pannello (cm) - Panel width (cm) - Largeur panneau (cm) - Paneelebreite (cm) - Ancho panel (cm) - Szerokość panelu (cm)

PEGASO

FIN 25 - 312

5 vie - 5 ways - 5 voies - 5läufig - 5 vías - 5 biegi

L - cm CT	220						240						260						280					
	A	B	C	D	E	F	A	B	C	D	E	F	A	B	C	D	E	F	A	B	C	D	E	F
160																								
180																								
200																								
220																								
240																								
260																								
280																								
300																								
320																								
LP - cm	50						54						58						62					

L - cm CT	300						320						340						360					
	A	B	C	D	E	F	A	B	C	D	E	F	A	B	C	D	E	F	A	B	C	D	E	F
160																								
180																								
200																								
220																								
240																								
260																								
280																								
300																								
320																								
LP - cm	66						70						74						78					

Maggiorazioni - Surcharges - Suppléments - Zuschläge - Suplementos - Dodatkowa opłata

L - cm	220	240	260	280	300	320	340	360
67								

Movimento a corda - Corded systems - Tirage - Schnurbedienung - Movimiento de cuerda - Koszt mechanizmu

L - cm	220	240	260	280	300	320
25 - 67 - 312						

FIN = Finitura - Finish - Finition - Fertigung - Acabado - Wykończenie

L = Larghezza sistema (cm) - System width (cm) - Largeur système (cm) - Gesamtbreite (cm) - Ancho sistema (cm) - Szerokość systemu (cm)

CT = Classe tessuto - Fabric category - Catégorie tissu - Gewebegruppe - Categoría tejido - Klasa tkaniny

C = Altezza tessuto (cm) - Fabric height (cm) - Hauteur de la toile (cm) - Stoff Höhe (cm) - Altura tejido (cm) - Wysokość tkaniny (cm)

LP = Larghezza pannello (cm) - Panel width (cm) - Largeur panneau (cm) - Paneelebreite (cm) - Ancho panel (cm) - Szerokość panelu (cm)

PEGASO

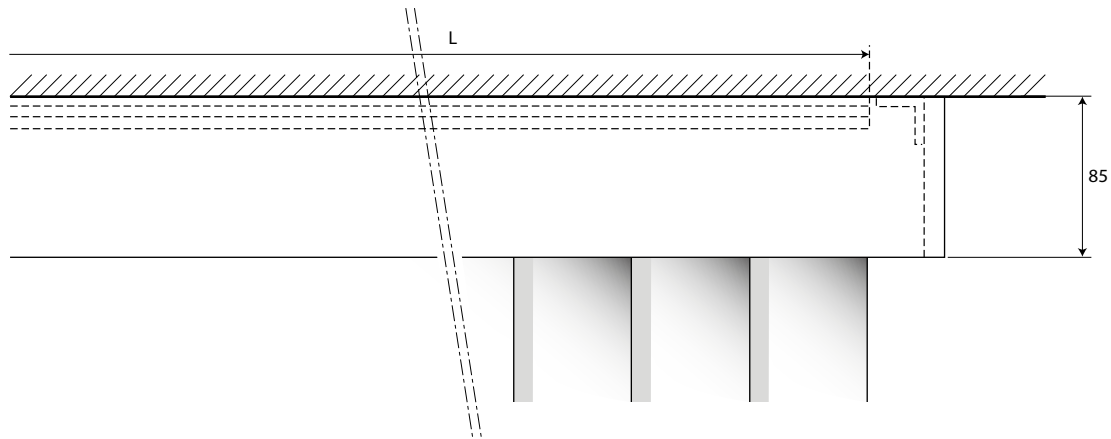

Cod. 923T03

Sistema a soffitto - 3 vie
Ceiling system - 3 ways
Système plafond - 3 voies
Deckenmontage - 3läufig
Sistema techo - 3 vías
System sufitowy - 3 biegi

Cod. 923T04

Sistema a soffitto - 4 vie
Ceiling system - 4 ways
Système plafond - 4 voies
Deckenmontage - 4läufig
Sistema techo - 4 vías
System sufitowy - 4 biegi

Cod. 923T05

Sistema a soffitto - 5 vie
Ceiling system - 5 ways
Système plafond - 5 voies
Deckenmontage - 5läufig
Sistema techo - 5 vías
System sufitowy - 5 biegi

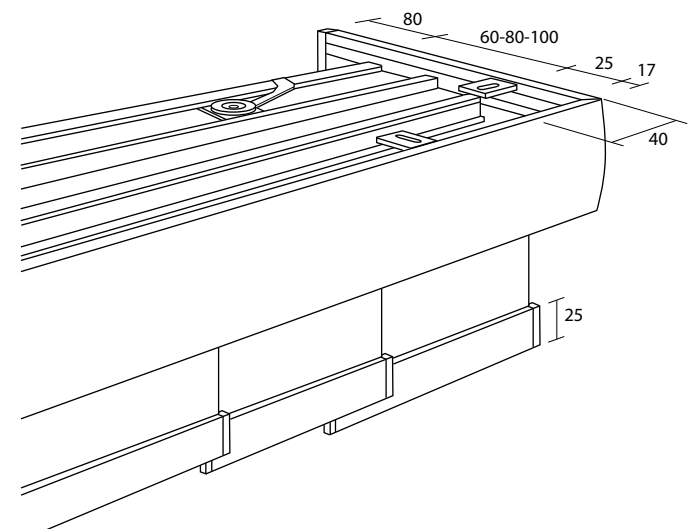

25



67



312

PEGASO

FIN 25 - 312

3 vie - 3 ways - 3 voies - 3läufig - 3 vías - 3 biegi

L - cm CT	140						160						180						200					
	A	B	C	D	E	F	A	B	C	D	E	F	A	B	C	D	E	F	A	B	C	D	E	F
160																								
180																								
200																								
220																								
240																								
260																								
280																								
300																								
320																								
LP - cm	53						59						66						73					

L - cm CT	220						250						300					
	A	B	C	D	E	F	A	B	C	D	E	F	A	B	C	D	E	F
160																		
180																		
200																		
220																		
240																		
260																		
280																		
300																		
320																		
LP - cm	79						90						106					

Maggiorazioni - Surcharges - Suppléments - Zuschläge - Suplementos - Dodatkowa opłata

L - cm	140	160	180	200	220	250	300
67							

Movimento a corda - Corded systems - Tirage - Schnurbedienung - Movimiento de cuerda - Koszt mechanizmu

L - cm	140	160	180	200	220	250	300
25 - 67 - 312							

FIN = Finitura - Finish - Finition - Fertigung - Acabado - Wykończenie

L = Larghezza sistema (cm) - System width (cm) - Largeur système (cm) - Gesamtbreite (cm) - Ancho sistema (cm) - Szerokość systemu (cm)

CT = Classe tessuto - Fabric category - Catégorie tissu - Gewebegruppe - Categoría tejido - Klasa tkaniny

C = Altezza tessuto (cm) - Fabric height (cm) - Hauteur de la toile (cm) - Stoff Höhe (cm) - Altura tejido (cm) - Wysokość tkaniny (cm)

LP = Larghezza pannello (cm) - Panel width (cm) - Largeur panneau (cm) - Paneelebreite (cm) - Ancho panel (cm) - Szerokość panelu (cm)

FIN 25 - 312

4 vie - 4 ways - 4 voies - 4läufig - 4 vías - 4 biegi

L - cm CT	180						200						220						240					
	A	B	C	D	E	F	A	B	C	D	E	F	A	B	C	D	E	F	A	B	C	D	E	F
160																								
180																								
200																								
220																								
240																								
260																								
280																								
300																								
320																								
LP - cm	51						56						61						66					

L - cm CT	260						280						300						320					
	A	B	C	D	E	F	A	B	C	D	E	F	A	B	C	D	E	F	A	B	C	D	E	F
160																								
180																								
200																								
220																								
240																								
260																								
280																								
300																								
320																								
LP - cm	71						76						81						86					

Maggiorazioni - Surcharges - Suppléments - Zuschläge - Suplementos - Dodatkowa opłata

L - cm	180	200	220	240	260	280	300	320
67								

Movimento a corda - Corded systems - Tirage - Schnurbedienung - Movimiento de cuerda - Koszt mechanizmu

L - cm	180	200	220	240	260	280	300	320
25 - 67 - 312								

FIN = Finitura - Finish - Finition - Fertigung - Acabado - Wykończenie
L = Larghezza sistema (cm) - System width (cm) - Largeur système (cm) - Gesamtbreite (cm) - Ancho sistema (cm) - Szerokość systemu (cm)
CT = Classe tessuto - Fabric category - Catégorie tissu - Gewebegruppe - Categoría tejido - Klasa tkaniny
C = Altezza tessuto (cm) - Fabric height (cm) - Hauteur de la toile (cm) - Stoff Höhe (cm) - Altura tejido (cm) - Wysokość tkaniny (cm)
LP = Larghezza pannello (cm) - Panel width (cm) - Largeur panneau (cm) - Paneelebreite (cm) - Ancho panel (cm) - Szerokość panelu (cm)

PEGASO

FIN 25 - 312

5 vie - 5 ways - 5 voies - 5läufig - 5 vías - 5 biegi

L - cm CT	220						240						260						280					
	A	B	C	D	E	F	A	B	C	D	E	F	A	B	C	D	E	F	A	B	C	D	E	F
160																								
180																								
200																								
220																								
240																								
260																								
280																								
300																								
320																								
LP - cm	50						54						58						62					

L - cm CT	300						320						340						360					
	A	B	C	D	E	F	A	B	C	D	E	F	A	B	C	D	E	F	A	B	C	D	E	F
160																								
180																								
200																								
220																								
240																								
260																								
280																								
300																								
320																								
LP - cm	66						70						74						78					

Maggiorazioni - Surcharges - Suppléments - Zuschläge - Suplementos - Dodatkowa opłata

L - cm	220	240	260	280	300	320	340	360
67								

Movimento a corda - Corded systems - Tirage - Schnurbedienung - Movimiento de cuerda - Koszt mechanizmu

L - cm	220	240	260	280	300	320
25 - 67 - 312						

FIN = Finitura - Finish - Finition - Fertigung - Acabado - Wykończenie

L = Larghezza sistema (cm) - System width (cm) - Largeur système (cm) - Gesamtbreite (cm) - Ancho sistema (cm) - Szerokość systemu (cm)

CT = Classe tessuto - Fabric category - Catégorie tissu - Gewebegruppe - Categoría tejido - Klasa tkaniny

C = Altezza tessuto (cm) - Fabric height (cm) - Hauteur de la toile (cm) - Stoff Höhe (cm) - Altura tejido (cm) - Wysokość tkaniny (cm)

LP = Larghezza pannello (cm) - Panel width (cm) - Largeur panneau (cm) - Paneelebreite (cm) - Ancho panel (cm) - Szerokość panelu (cm)

PEGASO

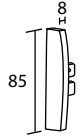

853111
Tappo
End cap
Bouchon

Endkappe
Tapón
Zatyczka

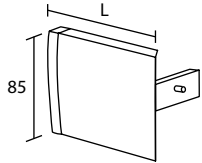

9230--
Angolare
Corner
Angle

Kante
Ángulo
Narozny

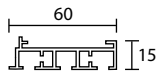

703003
Binario 3 vie
3 Ways track
Rail 3 voies
3läufige Schiene
Riel 3 vías
Prowadnica trzywałkowa

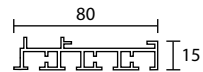

703004
Binario 4 vie
4 Ways track
Rail 4 voies
4läufige Schiene
Riel 4 vías
Prowadnica pięciwałkowa

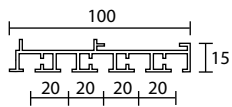

703005
Binario 5 vie
5 Ways track
Rail 5 voies

5läufige Schiene
Riel 5 vías
Prowadnica pięciwałkowa

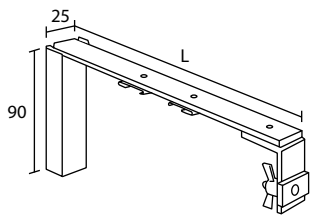

5533--
Supporto doppio con cover
Double bracket with cover
Support double avec couverture
Doppelträger mit Deckel
Soporte doble con cover
Wspornik podwójny z nakładką

Vie = Ways - Voies - Schiene - Vías - Biegi

Cod.	853111SX / DX		
FIN			
25 - 312			
67			

Cod.		923035	923045	923055
FIN	L - mm	177	197	217
25 - 312				
67				

Cod.		703003	703004
FIN	Vie	3	4
25 - 312			
67			

Cod.		703005
FIN	Vie	5
25 - 312		
67		

Cod.		553309	553319	553329
FIN	L - mm	90	160	210
25 - 312				
67				

PEGASO

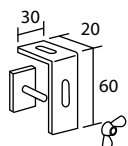

853018
Supporto a soffitto
Ceiling bracket
Support à plafond
Deckenträger
Soporte a techo
Wspornik do sufitu

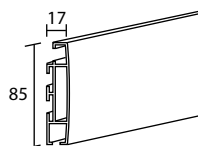

853200
Profilo frontale
Frontal profile
Profil frontal
Blende
Perfil frontal
Profil przedni

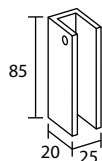

853102
Rosetta a muro
Recess bracket
Naissance murale
Wandlager
Soporte lateral
Podkładka do muru

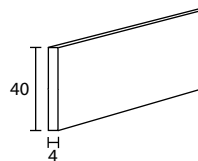

403190
Peso interno
Internal weight
Barre de lestage interne
Interne Beschwerungsprofil
Perfil contrapeso interior
Obciążnik wewnętrzny

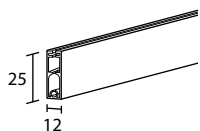

253120
Peso
Weight bar
Barre de lestage
Beschwerungsprofil
Perfil contrapeso
Obciążnik



253135
Tappo per peso
Endcap for weight bar
Bouchon pour barre de lestage
Endkappe Für Beschwerungsprofil
Tapón para contrapeso
Zaślepka obciążnika

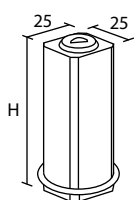

5630--
Fiocco piatto
Flat weight
Contrepoids plat

Schnurbeschwerer
Contrapeso plano
Obciążnik płaski

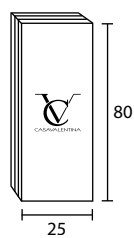

513099
Maniglia
Handle
Poignée
Klinke
Manivela
Raczka

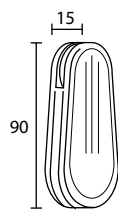

5010
Fiocco in plastica ABS
Plastic cord weight
Contrepoids en plastique
Schnurbeschwerer aus "ABS"
Contrapeso de plástico
Obciążnik plastikowy

Vie = Vie - Ways - Voies - Schiene - Vias - Biegi

Cod.		853018	853200
FIN	L - mt		1
25 - 312			
67			

Cod.		853102	403190
FIN	L - mt		1
25 - 312			
67			

Cod.		253120	253135
FIN	L - mt	1	
25 - 312			
67			

Cod.		563007	563008
FIN	H - mm	80	100
25 - 312			
67			

Cod.		513099	5010
FIN			
25			
65 - 67			
81 - 312			