

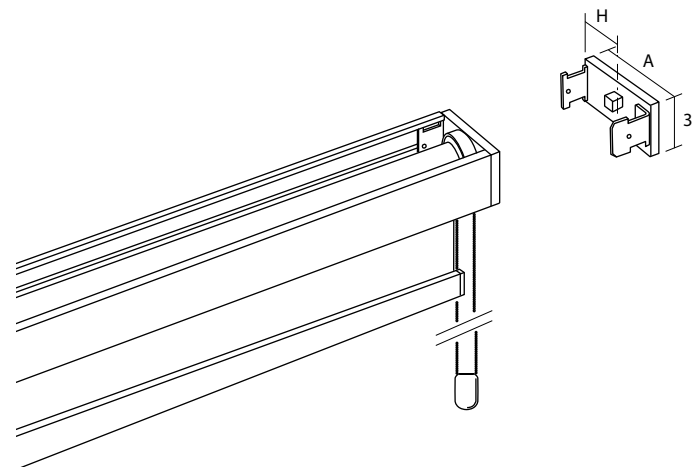

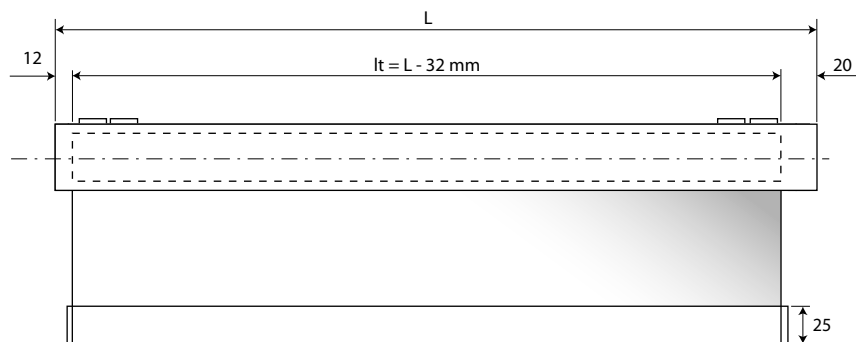

CRUX SPECIAL 25



Cod. 593A15...SX / DX

Sistema a parete
Wall system

Système de face
Wandmontage

Sistema pared
System ścienny

Cod.	593406SX / DX	593426SX / DX	593416SX / DX
A - mm	62	80	90
H - mm	28	40	42

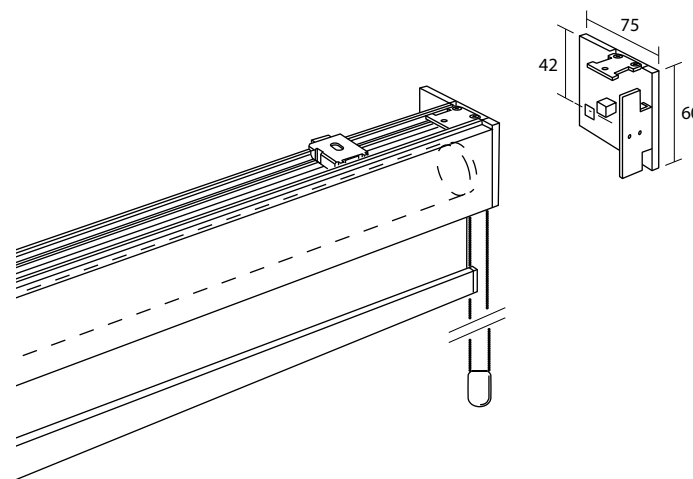
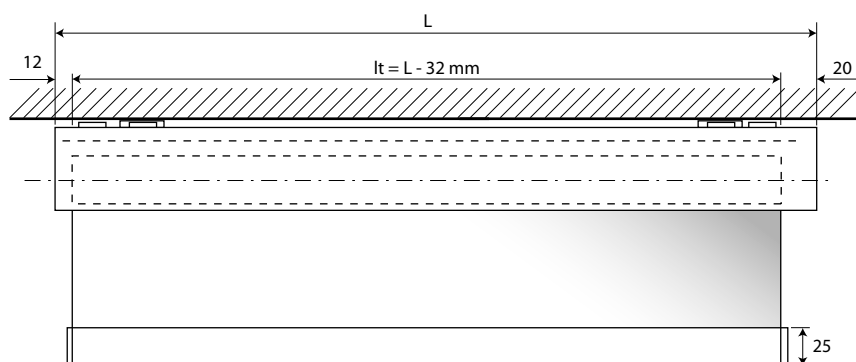

Cod. 593T15...SX / DX

Sistema a soffitto
Ceiling system

Système plafond
Deckenmontage

Sistema techo
System sufitowy



18



25



67



312

A = Sporgenza supporto - Bracket's projection - Retour support - Träger Abstand - Escuadra de separación - Występ wspornika
H = Distanza parete - Wall distance - Retour du mur - Wand Abstand - Distancia pared - Odległość od ściany
L = Larghezza sistema (cm) - System width (cm) - Largeur système (cm) - Gesamtbreite (cm) - Ancho sistema (cm) - Szerokość systemu (cm)
It = Larghezza singolo tessuto - Fabric width per unit - Largeur chaque toile - Stoff Breite - Ancho de cada tejido - Szerokość pojedynczej tkaniny



FIN 18 - 25 - 312

Supporti - Brackets - Supports - Träger - Soportes - Wsporniki Cod. 593406 - 593506

L - cm CT	60						80						100					
	A	B	C	D	E	F	A	B	C	D	E	F	A	B	C	D	E	F
80	C - cm																	
100																		
120																		
140																		
160																		
180																		

Spessore tessuto non superiore a 0,5 mm - Fabric thickness not exceeding 0,5 mm - Épaisseur tissu pas supérieur à 0,5 mm
 Gewebestärke nicht über 0,5 mm - Grosor tejido no superior a 0,5 mm - Grubość tkaniny nieprzekraczająca 0,5 mm

L - cm CT	120						140					
	A	B	C	D	E	F	A	B	C	D	E	F
80	C - cm											
100												
120												
140												
160												
180												

Spessore tessuto non superiore a 0,5 mm - Fabric thickness not exceeding 0,5 mm - Épaisseur tissu pas supérieur à 0,5 mm
 Gewebestärke nicht über 0,5 mm - Grosor tejido no superior a 0,5 mm - Grubość tkaniny nieprzekraczająca 0,5 mm

Maggiorazioni - Surcharges - Suppléments - Zuschläge - Suplementos - Dodatkowa opłata

67	
N&D	

Guide nylon - Nylon giude - Guidage nylon - Gleitkabel aus Nylon - Guías nylon - Prowadnicami nylonowymi

FIN = Finitura - Finish - Finition - Fertigung - Acabado - Wykończenie

L = Larghezza sistema (cm) - System width (cm) - Largeur système (cm) - Gesamtbreite (cm) - Ancho sistema (cm) - Szerokość systemu (cm)

CT = Classe tessuto - Fabric category - Catégorie tissu - Gewebegruppe - Categoría tejido - Klasa tkaniny

C = Altezza tessuto (cm) - Fabric height (cm) - Hauteur de la toile (cm) - Stoff Höhe (cm) - Altura tejido (cm) - Wysokość tkaniny (cm)

CRUX

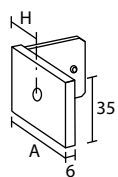

509406 509416

Crux lato perno
Crux pivot side
Crux côté pivot
Crux Träger Achseseite
Crux lado pivote
Crux strona czopa

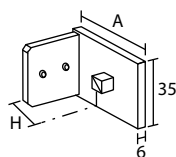

509405 509415

Crux lato catena
Crux chain side
Crux côté chainette
Crux Träger Ketteseite
Crux lado cadena
Crux strona łańcuszka

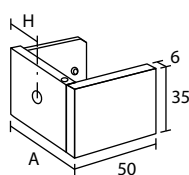

559405 559415

Crux Plus lato perno
Crux Plus pivot side
Crux Plus côté pivot
Crux Plus Träger Achseseite
Crux Plus lado pivote
Crux Plus strona czopa

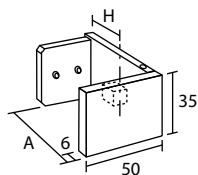

559406 559416

Crux Plus lato catena
Crux Plus chain side
Crux Plus côté chainette
Crux Plus Träger Ketteseite
Crux Plus lado cadena
Crux Plus strona łańcuszka

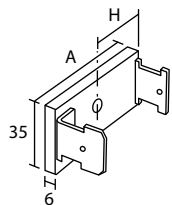

5934--

Crux Special 25 lato perno
Crux Special 25 pivot side
Crux Special 25 côté pivot
Crux Special 25 Träger Achseseite
Crux Special 25 lado pivote
Crux Special 25 strona czopa

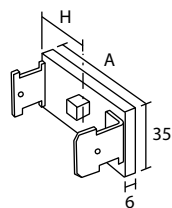

59340--

Crux Special 25 lato catena
Crux Special 25 chain side
Crux Special 25 côté chainette
Crux Special 25 Träger Ketteseite
Crux Special 25 lado cadena
Crux Special 25 strona łańcuszka

SISTEMA A PARETE - WALL SYSTEM - SYSTÈME DE FACE - WANDMONTAGE - SISTEMA PARED - SYSTEM ŚCIENNY

Cod.		509406SX / DX	509416SX / DX	509405SX / DX	509415SX / DX
FIN	A - mm	48	66	48	66
	H - mm	28	36	28	36
18 - 25 - 312					
67					

Cod.		559405SX / DX	559415SX / DX	559406SX / DX	559416SX / DX
FIN	A - mm	54	72	54	72
	H - mm	28	36	28	36
18 - 25 - 312					
67					

Cod.		593405SX / DX	593415SX / DX	593425SX / DX
FIN	A - mm	62	80	90
	H - mm	28	40	42
18 - 25 - 312				
67				

Cod.		593406SX / DX	593416SX / DX	593426SX / DX
FIN	A - mm	62	80	90
	H - mm	28	40	42
18 - 25 - 312				
67				

CRUX

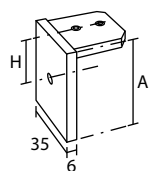

509506 509516
 Crux lato perno
 Crux pivot side
 Crux côté pivot
 Crux Träger Achseseite
 Crux lado pivote
 Crux strona czopa

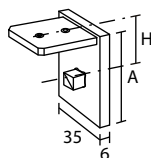

509505 509515
 Crux lato catena
 Crux chain side
 Crux côté chainette
 Crux Träger Ketteseite
 Crux lado cadena
 Crux strona łańcuszka

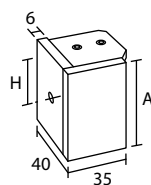

559506 559516
 Crux Plus lato perno
 Crux Plus pivot side
 Crux Plus côté pivot
 Crux Plus Träger Achseseite
 Crux Plus lado pivote
 Crux Plus strona czopa

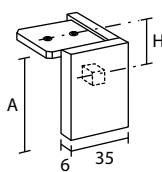

559505 559515
 Crux Plus lato catena
 Crux Plus chain side
 Crux Plus côté chainette
 Crux Plus Träger Ketteseite
 Crux Plus lado cadena
 Crux Plus strona łańcuszka

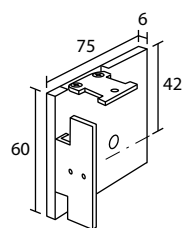

593504
 Crux Special 25 lato perno
 Crux Special 25 pivot side
 Crux Special 25 côté pivot
 Crux Special 25 Träger Achseseite
 Crux Special 25 lado pivote
 Crux Special 25 strona czopa

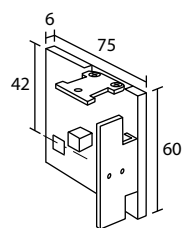

593506
 Crux Special 25 lato catena
 Crux Special 25 chain side
 Crux Special 25 côté chainette
 Crux Special 25 Träger Ketteseite
 Crux Special 25 lado cadena
 Crux Special 25 strona łańcuszka

SISTEMA A SOFFITTO - CEILING SYSTEM - SYSTÈME PLAFOND - DECKENMONTAGE - SISTEMA TECHO - SYSTEM SUFITOWY

Cod.		509506SX / DX	509516SX / DX	509505SX / DX	509515SX / DX
FIN	A - mm	48	66	48	66
	H - mm	28	36	28	36
18 - 25 - 312					
67					

Cod.		559506SX / DX	559516SX / DX	559505SX / DX	559515SX / DX
FIN	A - mm	54	72	54	72
	H - mm	31	62	31	62
18 - 25 - 312					
67					

Cod.		593504SX / DX
FIN		
18 - 25 - 312		
67		

Cod.		593506SX / DX
FIN		
18 - 25 - 312		
67		

CRUX

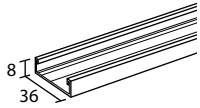

663899

Barra portarullo
Fixing bar
Barre de fixation

Rollenhalterungsstange
Barra de fijación
Wałek do rolety

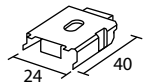

1055

Molla di fissaggio
Fixing spring
Ressort de fixation

Befestigungsfeder
Muelle de fijación
Mocowanie

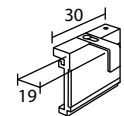

123024

Aggancio ausiliario per binario
Auxiliary hanger for tracks
Support pour chemin de fer
Hilfskoppelung für Schiene
Engancho auxiliar para riel
Dodatkowe zahaczenie dla szyny

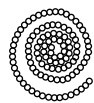

1032

Catena metallo cromata
Chromed metal chain
Chainette metal chromé
Verchromte Metallkette
Cadena metálica cromada
Łańcuszek metalowy chromowany

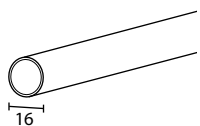

164100

Peso
Weight bar
Barre de lestage

Beschwerungsprofil
Perfil contrapeso
Obciążnik

COMPONENTI - COMPONENTS - COMPOSANTS - ZUBEHÖR - COMPONENTES - CZĘŚCI

Cod.		663899
FIN	L - mt	1
18 - 25 - 312		
67		

Cod.		1055
FIN		

Cod.		123024
FIN		
18 - 25 - 67 - 312		

Cod.		1032
FIN	L - mt	5
03		

Cod.		164100
FIN	L - mt	1
18 - 25 - 312		

CRUX

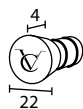

163055

Tappo per peso
Endcap for weight bar
Bouchon pour barre de lestage
Endkappe Für Beschwerungsprofil
Tapón para contrapeso
Zaślepka obciążnika

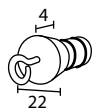

163245

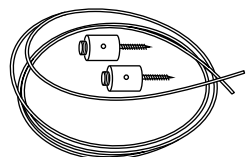

2355

Cavo laterale con fermo verticale
Side cable with vertical stop
Câble latéral avec arrêt vertical
Seitenkabel mit vertikaler Sperre
Cable lateral con tope vertical
Przewód boczny z ogranicznikiem pionowym

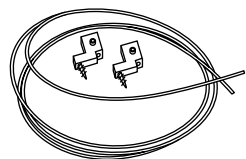

2356

Cavo laterale con fermo orizzontale
Side cable with horizontal stop
Câble latéral avec arrêt horizontal
Seitenkabel mit horizontaler Sperre
Cable lateral con tope horizontal
Przewód boczny z ogranicznikiem poziomym

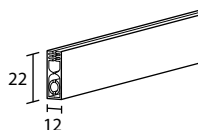

223120

Peso
Weight bar
Barre de lestage
Beschwerungsprofil
Perfil contrapeso
Obciążnik



223125

Tappo per peso
Endcap for weight bar
Bouchon pour barre de lestage
Endkappe Für Beschwerungsprofil
Tapón para contrapeso
Zaślepka obciążnika

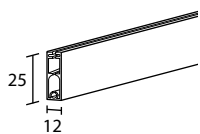

253120

Peso
Weight bar
Barre de lestage
Beschwerungsprofil
Perfil contrapeso
Obciążnik



253135

Tappo per peso
Endcap for weight bar
Bouchon pour barre de lestage
Endkappe Für Beschwerungsprofil
Tapón para contrapeso
Zaślepka obciążnika

COMPONENTI - COMPONENTS - COMPOSANTS - ZUBEHÖR - COMPONENTES - CZĘŚCI

Cod.	163055	163245
FIN		
18 - 25 - 312		
67		

Cod.	2355
FIN	

Cod.	2356
FIN	

Cod.	223120	223135
FIN	L - mt	1
18 - 25 - 312		
67		

Cod.	253120	253135
FIN	L - mt	1
18 - 25 - 312		
67		