

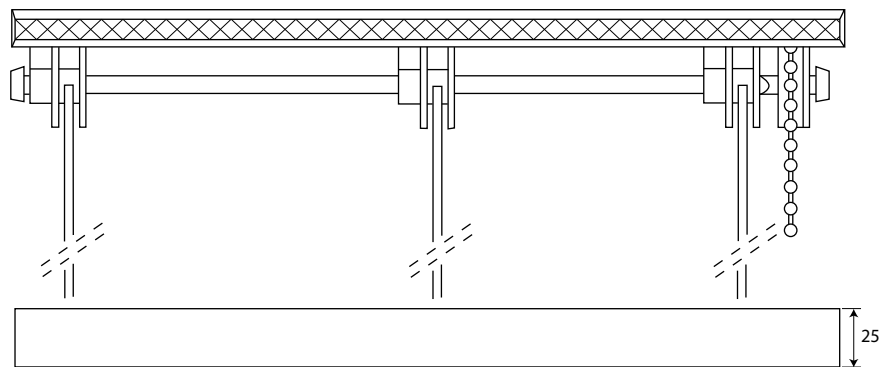



PACK SYSTEM



ADELE Cod. 223A45K*	CARMEN Cod. 513A41K*	MARCELLA Cod. 313A45K*	RITA Cod. 333A45K*
-------------------------------	--------------------------------	----------------------------------	------------------------------

Sistema a pacchetto a parete
 Wall mounting
 Store bateau fixation de face
 Raffvorhang-Systeme mit Wandbefestigung
 Sistema a paquete a pared
 Roleta rzymska montowana do ściany

ADELE Cod. 223S45K*	CARMEN Cod. 513T41K*	MARCELLA Cod. 313T45K*	RITA Cod. 333T45K*
-------------------------------	--------------------------------	----------------------------------	------------------------------

Sistema a pacchetto a soffitto
 Ceiling mounting
 Store bateau fixation plafond
 Raffvorhang-Systeme mit Deckenbefestigung
 Sistema a paquete a techo
 Roleta rzymska montowana do sufitu

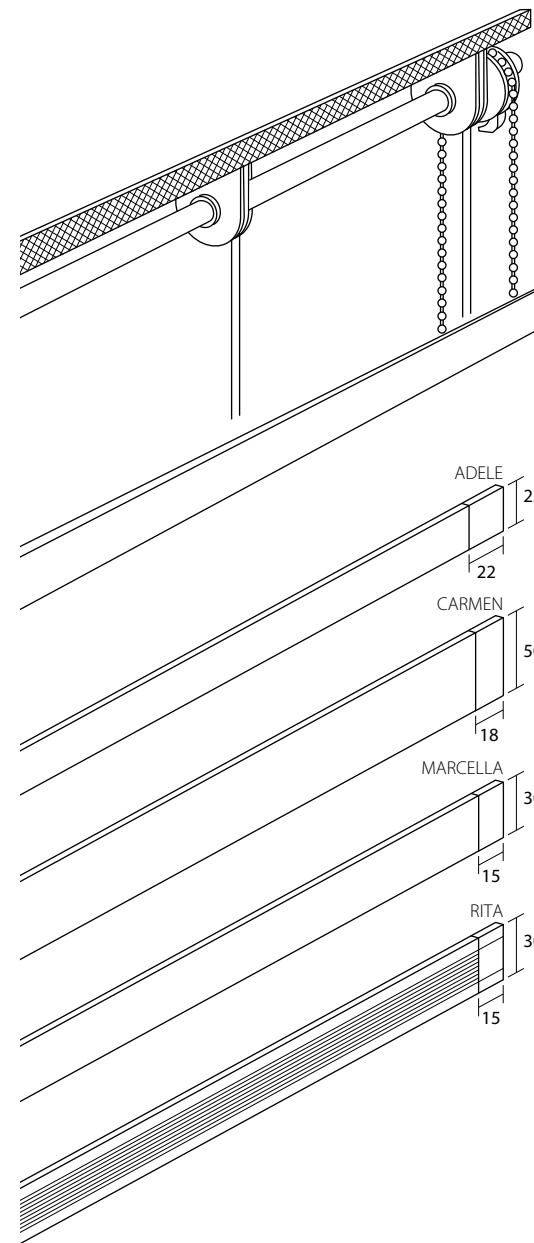

25



67



312

PACK SYSTEM

FIN 25 - 312

L - cm CT	80 C	100 C	120 C	140 C	160 C	180 C	200 C	220 C
80 C - cm								
100								
120								
140								
160								
180								
200								
220								
240								
260								
280								
n. Cad	2	2	4	4	5	5	6	6

* Il sistema monta solo i tessuti Nizza e Praga - For this system only fabrics Nizza and Praga - Pour ce système uniquement toiles Nizza and Praga
 Das System montiert nur die Stoffe Nizza und Praga - Para este sistema, sólo telas Nizza y Praga - Jedyne tkaniny używane w tym systemie to Nizza i Praga

Maggiorazioni - Surcharges - Suppléments - Zuschläge - Suplementos - Dodatkowa opłata

L - cm	80	100	120	140	160	180	200	220
67								

Catena in plastica trasparente (Maggiorazione per catena in metallo Euro 20,00) - Peso interno 30x4 mm
 Transparent plastic chain (Upcharge for metal chain Euro 20,00) - Internal bottom weight bar 30x4 mm
 Chainette plastique transparente (Supplément pour chainette métal Euro 20,00) - Barre de lestage interne 30x4 mm
 Durchsichtige Kunststoffkette (Zuschlag für Metalkette 20,00 Euro) - Internes Gewicht 30x4 mm
 Cadena plástica transparente (Suplemento para cadena metal Euro 20,00) - Perfil contrapeso interior 30x4 mm
 Przezroczysty łańcuch z tworzywa sztucznego (wzrost ceny za metalowy łańcuch 20,00 Eur) - Waga wewnętrzna 30x4 mm

FIN = Finitura - Finish - Finition - Fertigung - Acabado - Wykończenie
L = Larghezza sistema (cm) - System width (cm) - Largeur système (cm) - Gesamtbreite (cm) - Ancho sistema (cm) - Szerokość systemu (cm)
CT = Classe tessuto - Fabric category - Catégorie tissu - Gewebegruppe - Categoría tejido - Klasa tkaniny
C = Altezza tessuto (cm) - Fabric height (cm) - Hauteur de la toile (cm) - Stoff Höhe (cm) - Altura tejido (cm) - Wysokość tkaniny (cm)
Cad = Caduta - Drop - Chute - Falten - Caída - Sznurków

PACK SYSTEM

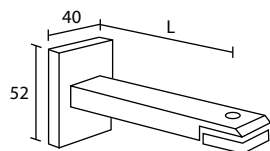

2234--

Supporto Adele
Bracket Adele
Support Adele

Träger Adele
Soporte Adele
Wspornik Adele

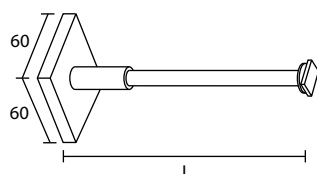

5133--

Supporto Carmen
Bracket Carmen
Support Carmen

Träger Carmen
Soporte Carmen
Wspornik Carmen

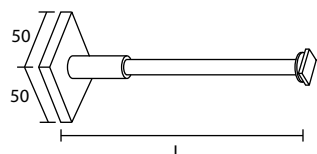

3133--

Supporto Marcella
Bracket Marcella
Support Marcella

Träger Marcella
Soporte Marcella
Wspornik Marcella

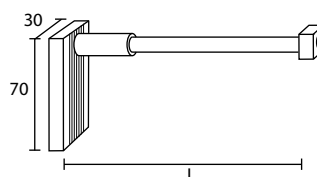

3331--

Supporto Rita
Bracket Rita
Support Rita

Träger Rita
Soporte Rita
Wspornik Rita

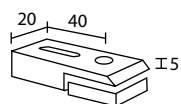

223997

Supporto Adele
Bracket Adele
Support Adele

Träger Adele
Soporte Adele
Wspornik Adele

SISTEMA A PARETE - WALL SYSTEM - SYSTÈME DE FACE - WANDMONTAGE - SISTEMA PARED - SYSTEM ŚCIENNY

Cod.		223418	223428
FIN	L - mm	90	160
25 - 312			
67			

Cod.		513318	513328
FIN	L - mm	160	210
25 - 312			
67			

Cod.		313318	313328
FIN	L - mm	160	210
25 - 312			
67			

Cod.		333119	333129
FIN	L - mm	160	210
25 - 312			
67			

SISTEMA A SOFFITTO - CEILING SYSTEM - SYSTÈME PLAFOND - DECKENMONTAGE - SISTEMA TECHO - SYSTEM SUFITOWY

Cod.		223997
FIN		
25 - 312		
67		

PACK SYSTEM

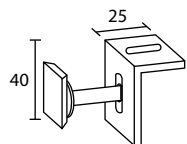

513598

Supporto Carmen
Bracket Carmen
Support Carmen

Träger Carmen
Soporte Carmen
Wspornik Carmen

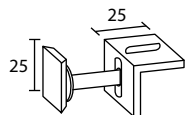

313598

Supporto Marcella - Rita
Bracket Marcella - Rita
Support Marcella - Rita

Träger Marcella - Rita
Soporte Marcella - Rita
Wspornik Marcella - Rita

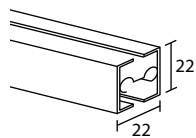

223110

Profilo Adele
Profile Adele
Profil Adele
Profil Adele
Perfil Adele
Profil Adele

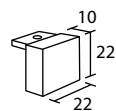

223145

Tappo strappo Adele
Simple endcap Adele
Bouchon simple Adele
Endkappe Adele
Tapón simple Adele
Zatyczka Adele

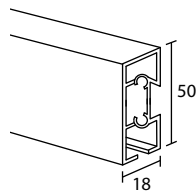

513100

Profilo Carmen
Profile Carmen
Profil Carmen
Profil Carmen
Perfil Carmen
Profil Carmen

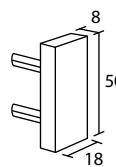

513041A

Terminale Carmen
Finial Carmen
Embout Carmen
Endstück Carmen
Terminal Carmen
Końcówka Carmen

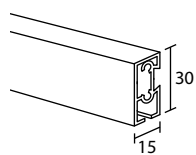

313300

Profilo Marcella
Profile Marcella
Profil Marcella
Profil Marcella
Perfil Marcella
Profil Marcella

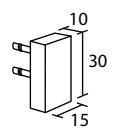

313045

Terminale Marcella
Finial Marcella
Embout Marcella
Endstück Marcella
Terminal Marcella
Końcówka Marcella

SISTEMA A SOFFITTO - CEILING SYSTEM - SYSTÈME PLAFOND - DECKENMONTAGE - SISTEMA TECHO - SYSTEM SUFITOWY

Cod.	513598
FIN	
25 - 312	
67	

Cod.	313598
FIN	
25 - 312	
67	

COMPONENTI - COMPONENTS - COMPOSANTS - ZUBEHÖR - COMPONENTES - CZĘŚCI

Cod.	223110	223145
FIN	L - mt	1
25 - 312		
67		

Cod.	513100	513041A
FIN	L - mt	1
25 - 312		
67		

Cod.	313300	313045SX / DX
FIN	L - mt	1
25 - 312		
67		

PACK SYSTEM

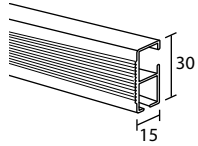

333100
 Profilo Rita
 Profile Rita
 Profil Rita
 Profil Rita
 Perfil Rita
 Profil Rita

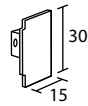

333041
 Terminale Rita
 Finial Rita Rita
 Embout Rita
 Endstück Rita
 Terminal Rita
 Końcówka Rita

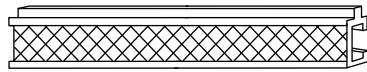

4030
 Profilo velcrato
 Velcro profile
 Profil velcro

Profil mit Klettverschluss
 Perfil velcrado
 I profil obciążnik

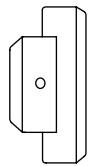

8608
 Tappo per profilo
 Endcap
 Bouchon pour profil

Profil/Endkappen
 Tapón perfil
 I zatyczka do profilu

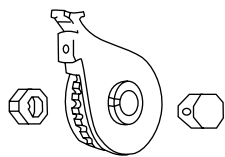

9008
 Comando auto.
 Auto reel
 Bobine de comm.

Kettenzug-Getriebe
 Carrete galón
 Napęd auto.

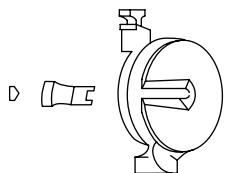

9009
 Rocchetto con clip
 Spool with clip
 Bobine avec clip

Spule mit Clip
 Carrete con clips
 I szpulka z zaciskiem

COMPONENTI - COMPONENTS - COMPOSANTS - ZUBEHÖR - COMPONENTES - CZĘŚCI

Cod.		333100	333041SX / DX
FIN	L - mt	1	
25 - 312			
67			

Cod.		4030	
	L - mt	1	

Cod.		8608	
-------------	--	-------------	--

Cod.		9008	
-------------	--	-------------	--

Cod.		9009	
-------------	--	-------------	--

PACK SYSTEM

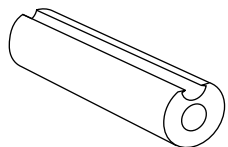

8905

Alberino
Spindle
Tige

Welle
Alberino
Profil

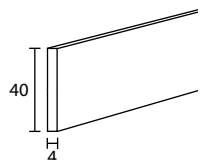

403190

Peso interno
Internal weight
Barre de lestage interne
Interne Beschwerungsprofil
Perfil contrapeso interior
Obciążnik wewnętrzny

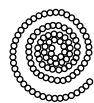

1032

Catena metallo cromata
Chromed metal chain
Chainette metal chromé
Verchromte Metallkette
Cadena metálica cromada
Łańcuszek metalowy chromowany

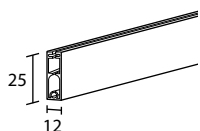

253120

Peso
Weight bar
Barre de lestage
Beschwerungsprofil
Perfil contrapeso
Obciążnik



253155

Tappo per peso
Endcap for weight bar
Bouchon pour barre de lestage
Endkappe Für Beschwerungsprofil
Tapón para contrapeso
Zaślepka obciążnika

COMPONENTI - COMPONENTS - COMPOSANTS - ZUBEHÖR - COMPONENTES - CZĘŚCI

Cod.	8905
L - mt	1

Cod.	403190
L - mt	1

Cod.	1032
FIN 03	L - mt 5

Cod.	253120
FIN 86 - 87 312	L - mt 1

Cod.	253155
FIN 86 - 87 312	